

DWG NO.	SH	REV
---------	----	-----

REVISIONS		
ZONE	REV	FINISHES:
		605, 609, 619, 620, 630 & DU
		GALUGE: 18ga. .050

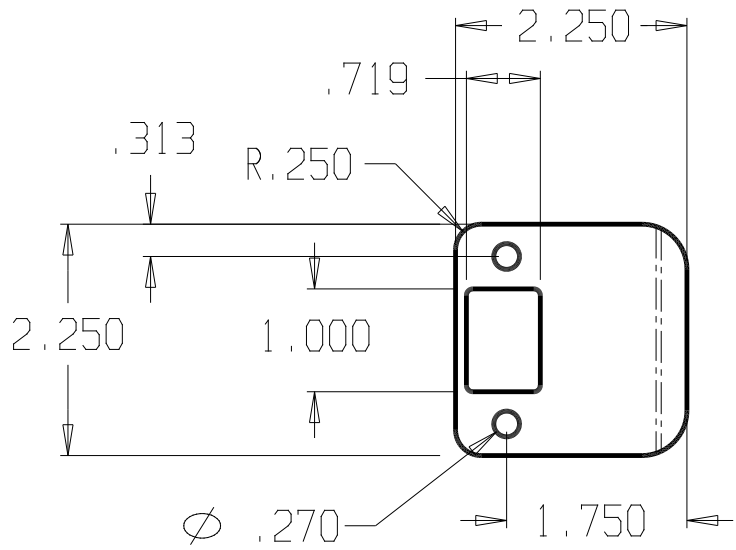

DON-JO MFG. INC.

DESIGNER
APPROVED

SIZE A	DATE: 5/13/04	PART NO. EL-175-RC	REV
SCALE	RELEASE DATE	WEIGHT	SHEET