

DWG NO.	SH	REV
---------	----	-----

REVISIONS		FINISHES:	GUAGE:
ZONE	REV	605, 609 & 630	18ga. .050

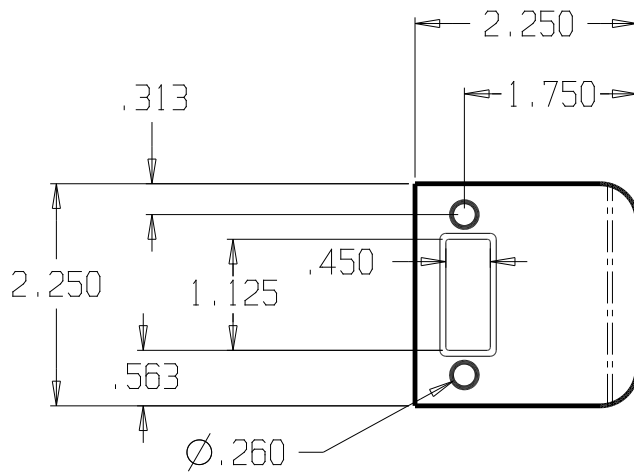

DON-JO MFG. INC.

DESIGNER	SIZE: A	DATE: 8/11/11	PART NO.: D9175	REV
APPROVED	SCALE	RELEASE DATE	WEIGHT	SHEET