

REVISIONS			
ZONE	REV	FINISHES:	GAUGE:
		PC	10ga. .134

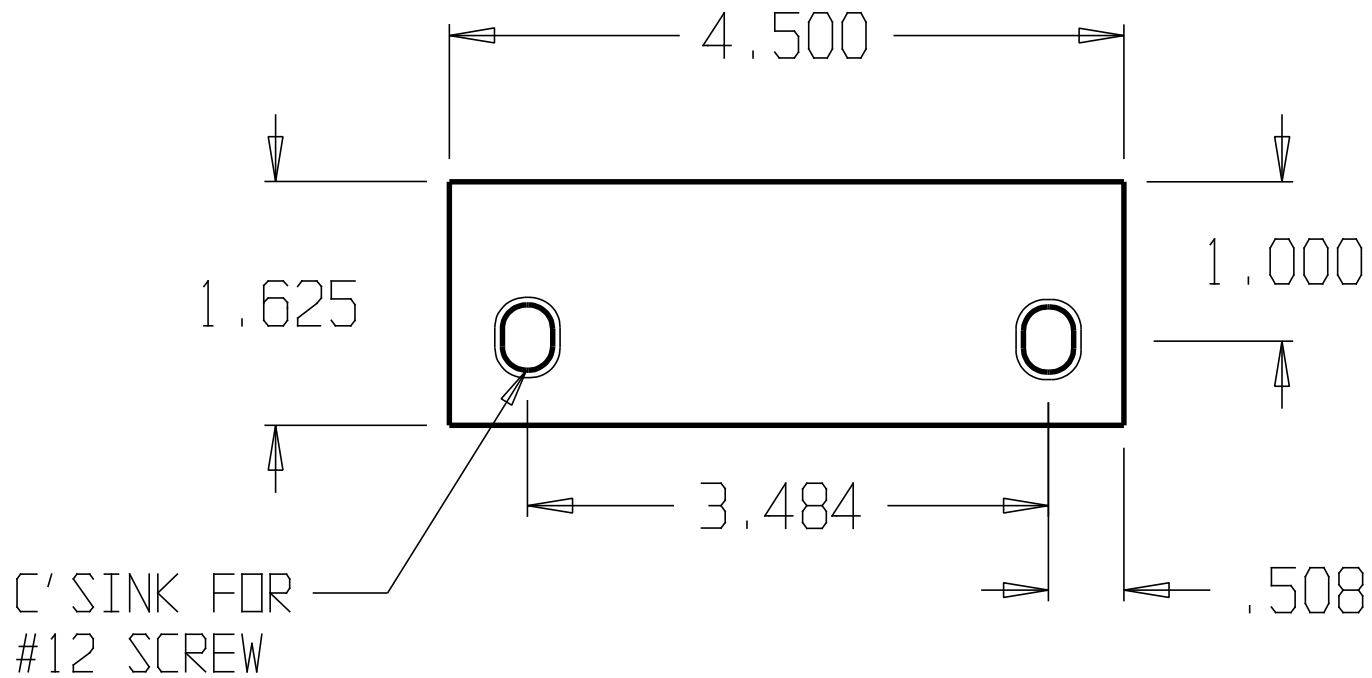

DON-JO MFG. INC.				SIZE	DATE:	PART NO.	REV
DESIGNER		A	5/19/04	FF-45			
APPROVED		SCALE	RELEASE DATE	WEIGHT	SHEET		