

REVISIONS			
ZONE	REV	FINISHES:	DATE
		605,613,619,620,626	
		APPROVED	

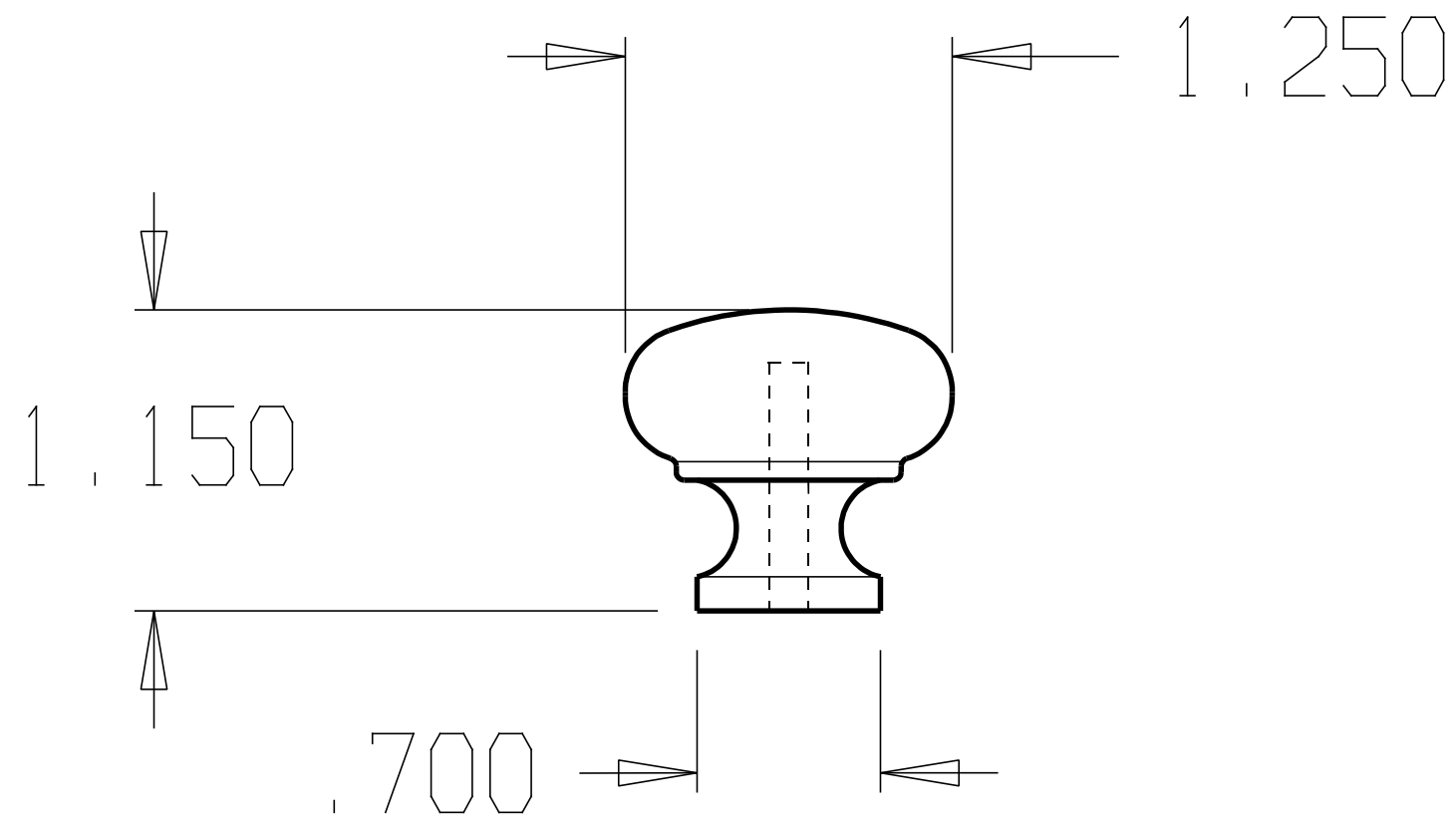

DON-JO MFG. INC.

DESIGNER	SIZE	DATE:	PART NO.	REV
	A	4/28/04	#54	
APPROVED	SCALE	RELEASE DATE	WEIGHT	SHEET