

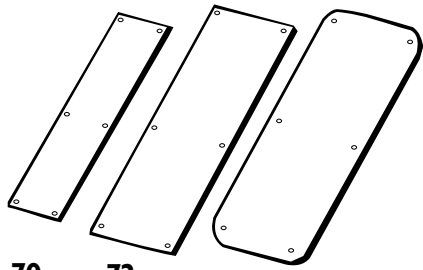

PUSH PLATES



70 72
71 73 72RC

NUMBER	ANSI	DIMENSIONS
70	J301	3 1/2" x 15"
71	J301	4" x 16"
72	J301	6" x 16"
73	J301	8" x 16"

SHELF PACK: 10

FINISHES: 605, 606, 609, 612, 613, 619, 620, 626, 628, 629, 630

- Beveled edges, adhesive mounting, rounded corners, cylinder cut-outs are available
- Other finishes include clear plastic and Kydex stock colors

PUSH PLATES & PULL PLATES WITH HOLES

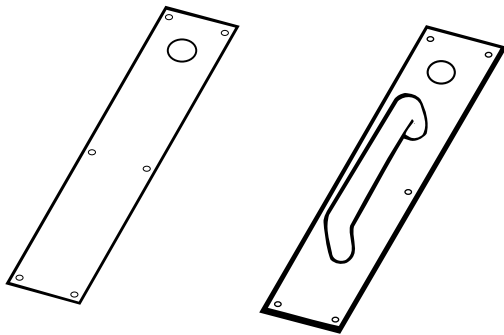

NUMBER	PULL	DIMENSIONS
*70	-	3 1/2" x 15"
*71	-	4" x 16"
*7015	15	3 1/2" x 15"
*7115	15	4" x 16"

SHELF PACK: (70, 71) 10

Box Packaged

(7015, 7115) 1

FINISHES: 605, 606, 612, 613, 628, 629, 630

***HOLE SIZE: CFC 1 1/4" - CFD 1 1/2" - CFK 2 1/8" - CFL 2 1/8" with lever prep**

How to Order: Hole Size, Number, Finish
e.g.: CFC70 - 605

CAST DOOR PULLS



10 35 36

NUMBER	CTC	DIMENSIONS	ANSI
10	5 1/2"	6 5/8" x 1 3/4" x 1 5/16"	J401
35	5 1/2"	7 1/2" x 2" x 1 1/2"	J401
36	5 1/2"	7 1/2" x 2" x 1 1/2"	J401

SHELF PACK: 1

• Dimensions - Overall x Projection x Clearance

FINISHES: (10) 605, 612, 613, 628, 630

(35, 36) 605, 613, 625, 626

HOSPITAL PULLS

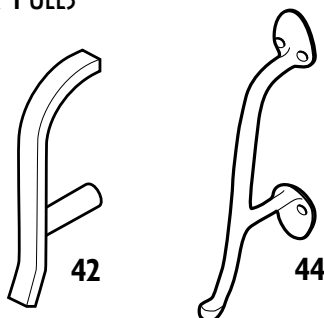

42 44

NUMBER	CTC	DIMENSIONS	ANSI
42	5"	6 1/2"	J401
44	6"	9 1/4"	J401

SHELF PACK: 1

FINISHES: (42) 605, 613, 626, 630

(44) 605, 613, 630

ROUND & FLAT DOOR PULLS

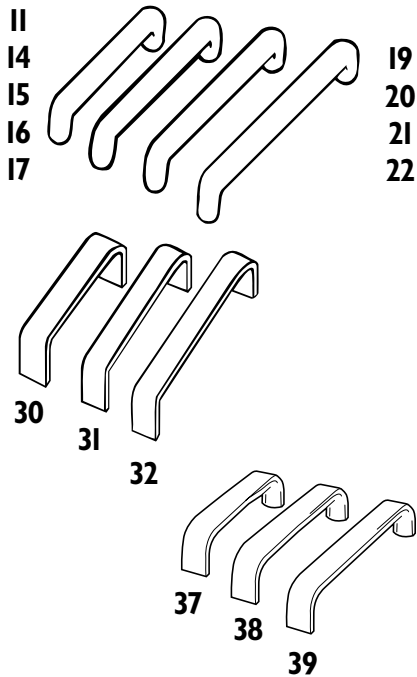

NUMBER	CTC	DIAMETER	ANSI	DIMENSIONS
11	5 1/2"	5/8"	J401	6 1/8" x 2" x 1 3/8"
14	5 1/2"	3/4"	J401	6 1/4" x 2 1/4" x 1 1/2"
15	6"	3/4"	J401	6 3/4" x 2 1/4" x 1 1/2"
16	8"	3/4"	J401	8 3/4" x 2 1/4" x 1 1/2"
17	10"	3/4"	J401	10 3/4" x 2 1/4" x 1 1/2"
19	8"	1"	J401	9" x 3" x 2"
20	10"	1"	J401	11" x 3" x 2"
21	12"	1"	J401	13" x 3" x 2"
22	18"	1"	J401	19" x 3" x 2"
30	6"	3/8" x 1 1/4"	J401	6 3/8" x 2" x 1 5/8"
31	8"	3/8" x 1 1/4"	J401	8 3/4" x 2" x 1 5/8"
32	10"	3/8" x 1 1/4"	J401	10 3/8" x 2" x 1 5/8"
37	6"	1" Half Round	J401	6 1/2" x 2" x 1 1/2"
38	8"	1" Half Round	J401	8 1/2" x 2" x 1 1/2"
39	10"	1" Half Round	J401	10 1/2" x 2" x 1 1/2"

SHELF PACK: I • Dimensions - Overall x Projection x Clearance

FINISHES: (11, 14, 15, 16, 17, 19, 20, 21, 22) 605, 606, 612, 613, 628, 629, 630

(30, 31, 32, 37, 38, 39) 605, 613, 628, 630

• For 2 1/2" clearance add prefix "H" - N/A on models 30 - 39

• Made from solid bar stock

PULL PLATES

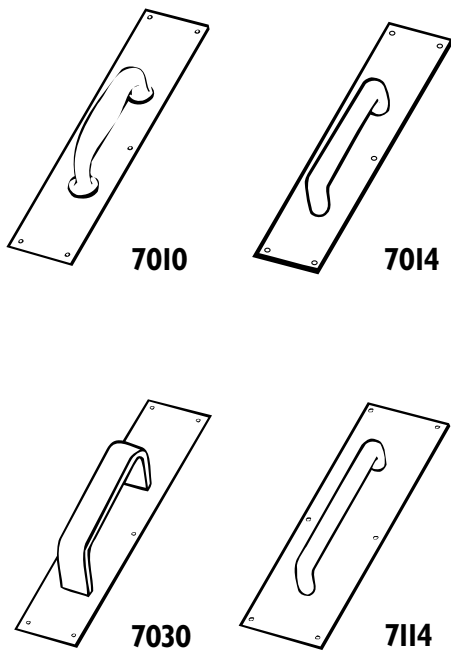

NUMBER	CTC	PULL	ANSI	DIMENSIONS
7010*	5 1/2"	6 5/8" x 1 3/4" x 1 15/16"	J405	3 1/2" x 15"
7011	5 1/2"	5/8"	J405	3 1/2" x 15"
7014	5 1/2"	3/4"	J405	3 1/2" x 15"
7015	6"	3/4"	J405	3 1/2" x 15"
7016	8"	3/4"	J405	3 1/2" x 15"
7030	6"	3/8" x 1 1/4"	J405	3 1/2" x 15"
7031	8"	3/8" x 1 1/4"	J405	3 1/2" x 15"
7110*	5 1/2"	6 5/8" x 1 3/4" x 1 15/16"	J405	4" x 16"
7111	5 1/2"	5/8"	J405	4" x 16"
7114	5 1/2"	3/4"	J405	4" x 16"
7115	6"	3/4"	J405	4" x 16"
7116	8"	3/4"	J405	4" x 16"
7130	6"	3/8" x 1 1/4"	J405	4" x 16"
7131	8"	3/8" x 1 1/4"	J405	4" x 16"
7210*	5 1/2"	6 5/8" x 1 3/4" x 1 15/16"	J405	6" x 16"
7310*	5 1/2"	6 5/8" x 1 3/4" x 1 15/16"	J405	8" x 16"

SHELF PACK: I

FINISHES: 605, 606, 612, 613, 628, 629, 630, *not available in 606

• For 2 1/2" clearance add prefix "H" (not available on all models)

• First two digits indicate plate size, second two digits indicate pull style

• Other sizes and combinations available. Contact factory



OFFSET DOOR PULLS

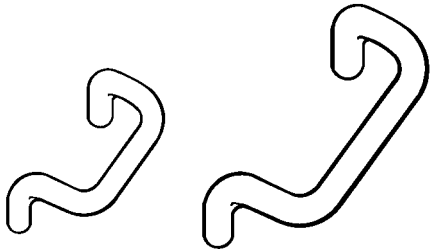

1150 / 1151
1152

1156 / 1157
1158 / 1159

NUMBER	CTC	DIAMETER	ANSI	DIMENSIONS
1150	8"	3/4"	J402	8 3/4" x 2 3/4" x 2"
1151	10"	3/4"	J402	10 3/4" x 2 3/4" x 2"
1152	12"	3/4"	J402	12 3/4" x 2 3/4" x 2"
1156	8"	1"	J402	9" x 3" x 2"
1157	10"	1"	J402	11" x 3" x 2"
1158	12"	1"	J402	13" x 3" x 2"
1159	18"	1"	J402	19" x 3" x 2"

SHELF PACK: 1
FINISHES: 605, 606, 613, 628, 629, 630
• Made from solid bar stock

• Dimensions - Overall x Projection x Clearance

PUSH/PULL BARS

PULL				PUSH			
NUMBER	CTC	PROJECTION	CLEARANCE	CTC	PROJECTION	CLEARANCE	ANSI
147	Specify	2 1/2"	1 1/2"	-	Specify	1 1/2"	J501
19147	8"	3"	2"	Specify	2 1/2"	1 1/2"	J504
20147	10"	3"	2"	Specify	2 1/2"	1 1/2"	J504
21147	12"	3"	2"	Specify	2 1/2"	1 1/2"	J504
22147	18"	3"	2"	Specify	2 1/2"	1 1/2"	J504
1156147	8"	3"	2"	Specify	2 1/2"	1 1/2"	J504
1157147	10"	3"	2"	Specify	2 1/2"	1 1/2"	J504
1158147	12"	3"	2"	Specify	2 1/2"	1 1/2"	J504
1159147	18"	3"	2"	Specify	2 1/2"	1 1/2"	J504

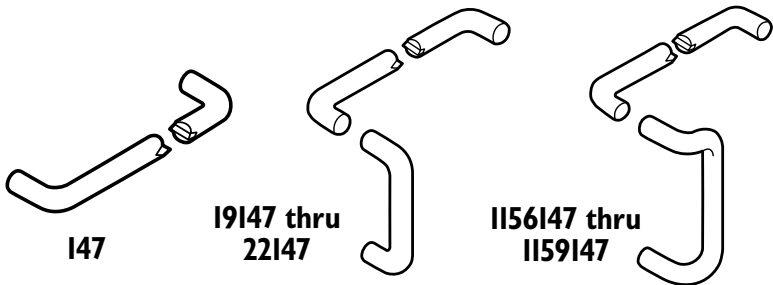

147

19147 thru
22147

1156147 thru
1159147

SHELF PACK: 1
FINISHES: 605, 606, 613, 628, 629, 630
• Made from solid bar stock

How to Order: Number, Size, Finish
eg: 22147 - 32" - 630

See page 13 for mounting options

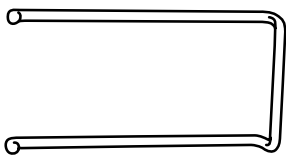

19148 thru 22148

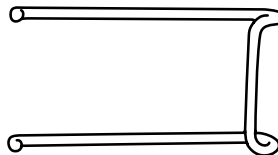

1156148 thru 1159148

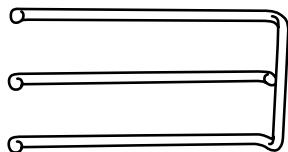

19149 thru 22149

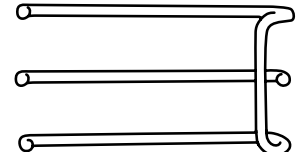

1156149 thru 1159149



PUSH/PULL PLATE

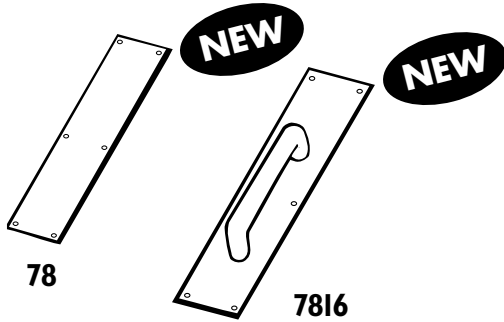

NUMBER	THICKNESS	DIMENSIONS	ANSI
78	.125	4" x 16"	J304
7816	.125	4" x 16"	J407

SHELF PACK: 1 Box Packaged

FINISHES: 630
10 (.125) Gauge

PUSH/PULL PLATE & CYLINDER PULL

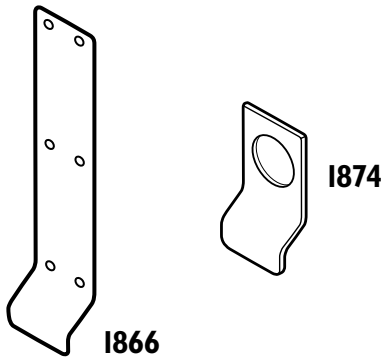

NUMBER	HOLE	DIMENSIONS	ANSI
1866	-	3 1/2" x 15 3/4"	J303
1874	1 1/4"	2" x 3 3/4"	J303

SHELF PACK: (1866) 1 Box Packaged
(1874) 10

FINISHES: 630
10 (.125) Gauge

FLUSH CUP PULLS

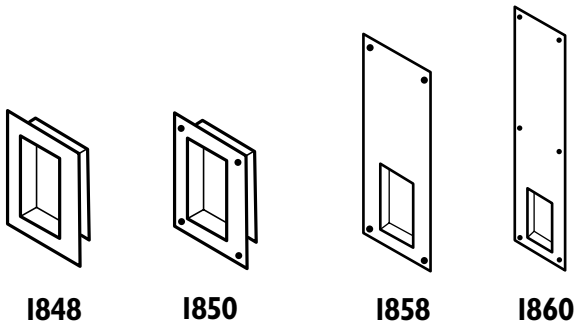

NUMBER	ANSI	DIMENSIONS
1848	J403	3 1/2" x 4 3/4"
1850	J403	3 1/2" x 4 3/4"
1858	J403	4" x 10"
1860	J403	4" x 16"

SHELF PACK: 10 Box Packaged

FINISHES: 630
16 (.062) Gauge

CABINET PULLS

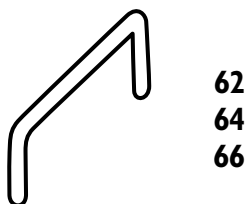

NUMBER	CTC	DIAMETER	ANSI
62	3"	5/16"	B22011
64	3 1/2"	5/16"	B22011
66	4"	5/16"	B22011

SHELF PACK: 10 Polybagged

FINISHES: 605, 625, 626
Includes both 1 1/4" and 2" screws

CABINET KNOB

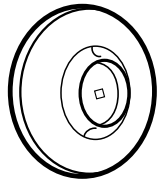

59

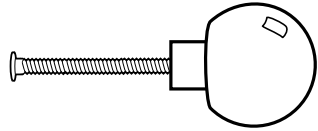

58

NUMBER	KNOB	BACK PLATE
58	1 1/4"	-
59	-	1 3/4"

SHELF PACK: 10
FINISHES: 605, 620, 625, 626

Polybagged

CABINET KNOB

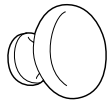

54
1 1/4"

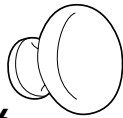

56
1 1/2"



NUMBER	ANSI
54	B12131
56	B12131

SHELF PACK: 10
FINISHES: 605, 613, 619, 620, 626
MATERIAL: Solid Brass

Polybagged

DISPLAY PACKAGED PUSH & PULL PLATES

PL-13515

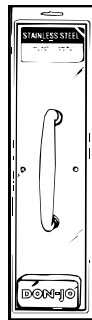

PS-13515

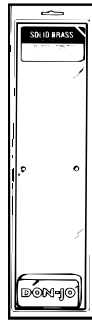

NUMBER	DIMENSIONS
PL-13515	3 1/2" x 15"
PS-13515	3 1/2" x 15"

SHELF PACK: 10
FINISHES: 605, 613, 630

Display Packaged Size - 4 1/4" x 17 1/4"
• Made of (.050) 18 gauge material

FASTENING METHODS FOR DOOR PULLS

1

Thru-Bolt

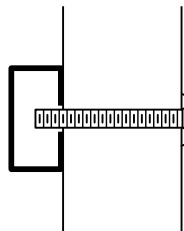

2

Surface
Concealed for
Wood Doors

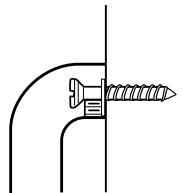

3

Back to Back
Base must
be at least
3/4" thick

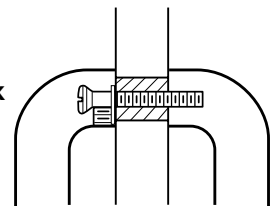

4

Decorative
Thru-Bolt
Glass Door

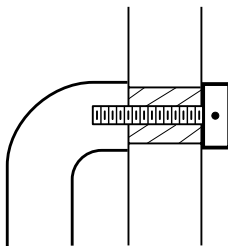

5

Back to Back
Glass Door
supplied with
5/8" Plexiglass
Sleeve with
Neoprene
Washers

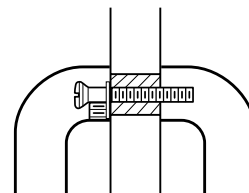

6

Surface Concealed
Base must be
at least 3/4" thick

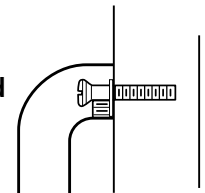

7

Back to back with
Two Concealed
studs welded to the
back of a Push Plate

