

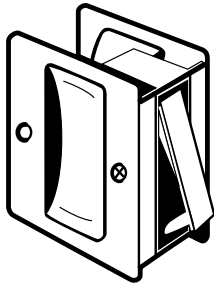

POCKET DOOR LOCKS

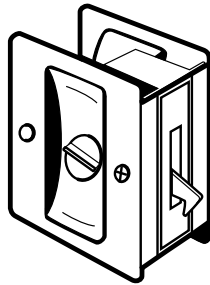

PDL-100
Passage



PDL-101
Privacy

NUMBER	DIMENSIONS	ANSI
PDL-100	2 1/2" x 2 3/4"	D082 I
PDL-101	2 1/2" x 2 3/4"	D083 I

- SHELF PACK: 10** **Box Packed**
FINISHES: 605, 609, 613, 619, 620, 622, 625, 626, 605x625
- Field Reversible
 - Adjustable for various door thickness
 - Includes pin & screws for 1 3/4" door width

SCAR PLATES used to convert 2 3/8" to 2 3/4" backset

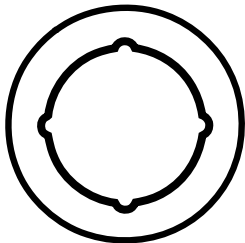

SP-135

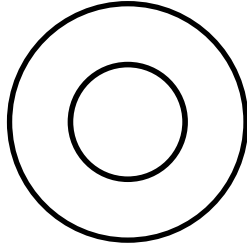

DSP-135

NUMBER	DIMENSIONS
SP-135	3 1/2" O.D.
DSP-135	3 1/2" O.D.

- SHELF PACK: 10** **Display Package Size - 5 1/4" x 6 1/2"**
FINISHES: 605, 609, 612, 630
- SP-135 fits under rose of key-in-knob or deadbolt locks
 - DSP-135 fits under deadbolt collars

Product available polybagged
 To order, add prefix "PB".
 I.E., SP-135 will become PBSP-135.

REMODELER PLATES for modernizing or decorating

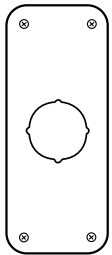

RP-13509

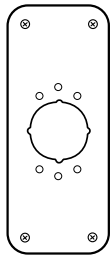

RP-13509-2

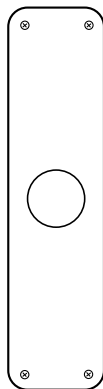

RP-13515

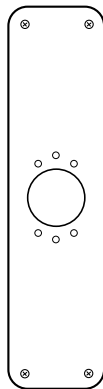

RP-13515-2

NUMBER	DIMENSIONS
RP-13509	3 1/2" x 9"
RP-13509-2	3 1/2" x 9"
RP-13515	3 1/2" x 15"
RP-13515-2	3 1/2" x 15"
RP-13545	3 1/2" x 4 1/2"
RP-13545-2	3 1/2" x 4 1/2"
RPK-109	3 1/2" x 9"

- SHELF PACK: 10** **Display Packaged Size - 7 1/2" x 13"**
Polybagged
- FINISHES: (RP-13509, RP-13509-2, RP-13545, RP-13545-2) 605, 609, 612, 630**
(RP-13515, RP-13515-2, RP-109) 605, 630
.032 thick

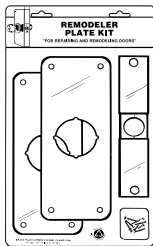

RPK-109

Kit Contains:
(2) RP-13509
(1) CV-86-C & all fasteners

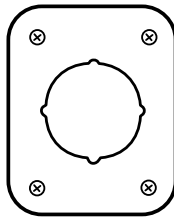

RP-13545

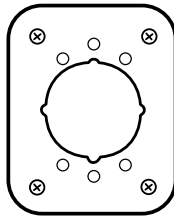

RP-13545-2

DOOR VIEWERS

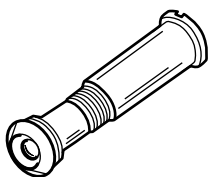

DV-90
ULDV-90
1/2" installation hole

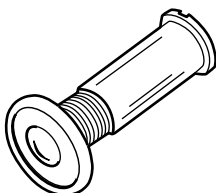

DV-180
ULDV-180
9/16" installation hole

NUMBER	VIEW DIMENS.	ANSI
DV-90	160 Degrees	L21372
DV-180	180 Degrees	L21371
ULDV-90	160 Degrees	L23222
ULDV-180	180 Degrees	L23221



SHELF PACK: 10
FINISHES: 605, 626
Polybagged
• For doors 1 3/8" to 2" thickness
• DV-90 and DV-180 with plastic lens
• ULDV-90 and ULDV-180 with glass lens are UL rated

HANDRAIL BRACKETS

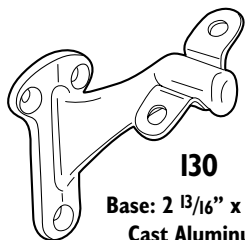

I30
Base: 2 13/16" x 1 1/2"
Cast Aluminum

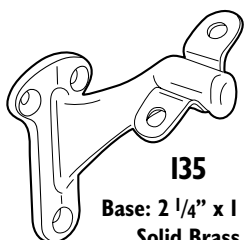

I35
Base: 2 1/4" x 1 1/4"
Solid Brass

NUMBER	MATERIAL	ANSI
I30	Cast Aluminum	L33061
I35	Solid Brass	L13061

SHELF PACK: (I30) 20 , (I35) 10
FINISHES: I30: 605, 609, 613, 619, 620, 625, 626
I35: 605, 613, 619, 620, 626
Polybagged

DOOR FLIP GUARDS

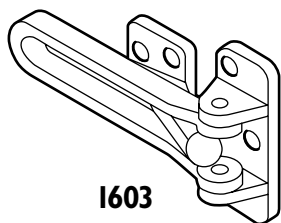

I603

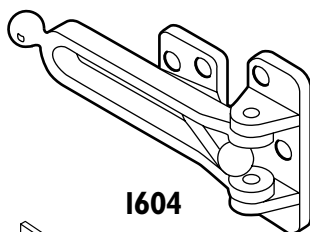

I604



AP-34
1" x 1" x 1/2"

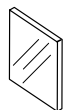

WP-34
1" x 1"

NUMBER	MATERIAL	ANSI
I603	Aluminum	L33042
I604	Brass	L13042
AP-34	-	-
WP-34	-	-

SHELF PACK: (I603, I604) 10
(AP-34, WP-34) 100
FINISHES: (I603, I604) 605, 606, 625, 626
(AP-34) 605, 606, 626
(WP-34) 605, 606, 626, Clear
• Black rubber shim available for I603 and I604
• AP-34 included with item I604
• Both models feature Ball Bearing Design

CHAIN GUARD

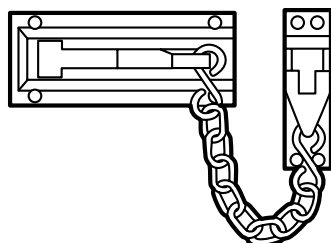

I607

NUMBER	MATERIAL
I607	Cast Brass

SHELF PACK: 20
FINISHES: Brass
Polybagged

SOLID BRASS REPLACEMENT KNOBS

BK-225

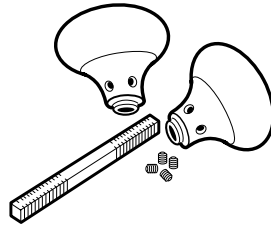

NUMBER	DIMENSIONS
BK-225	2 1/4"

SHELF PACK: 10 Display Packaged
 FINISHES: Solid Brass
 • Includes spindle, 4 set screws & 2 knobs

ELBOW CATCH

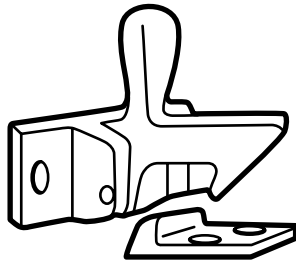

1590

NUMBER	MATERIAL
1590	Cast

SHELF PACK: 10 Polybagged
 FINISHES: 605, 625

HINGE PINS/WINDOW BOLTS

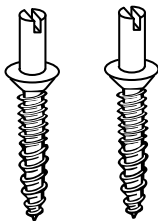

CHP-100
 RHP-100

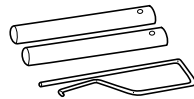

WB-112

NUMBER	DIMENSIONS
CHP-100	#12 Head
RHP-100	#10 Head
WB-112	Contains: 8 Bolts, 4 Tools

SHELF PACK: (CHP-100, RHP-100) 10 pack of 2 each Polybagged
 (WB-112) 10
 FINISHES: (CHP-100, RHP-100) BP (Brass Plated),
 CP (Chrome Plated)
 (WB-112) ZINC

COAT HOOKS

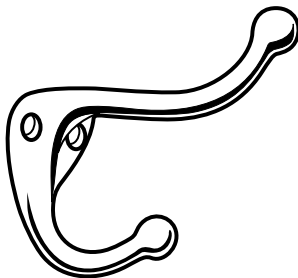

300

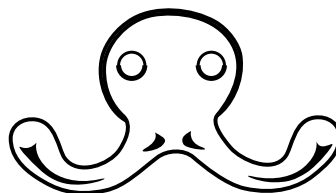

302

NUMBER	MATERIAL
300	Die Cast
302	Die Cast

SHELF PACK: 20 Polybagged
 FINISHES: 605, 613, 619, 620, 625

FINGER PULL

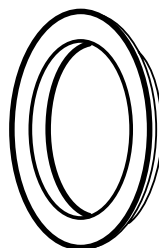

125

NUMBER	DIMENSIONS	MATERIAL
125	2 1/8"	Zinc

SHELF PACK: 50 Polybagged
 FINISHES: 605, 609, 613, 619, 620, 625, Black

SCAR PLATE for door damaged by prying

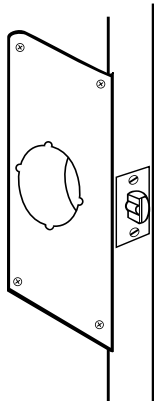

EM-2
EM-4

NUMBER	DIMENSIONS
EM-2	9" x 4" x 2 3/8"
EM-4	9" x 4 1/4" x 2 3/8"

SHELF PACK: 10 Polybagged
 FINISHES: 605, 630
 • Fits one side of door with curved lip
 • Fits under key-in-knob

CRASH CHAIN

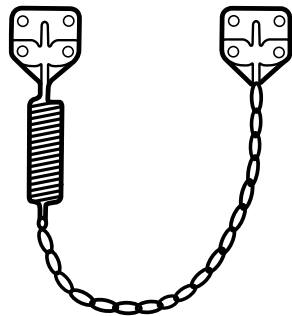

CC-100

NUMBER	CHAIN SIZE
CC-100	21 3/4"

SHELF PACK: 20 Polybagged
 FINISHES: Zinc
 • Vinyl Cover

EDGE PULLS

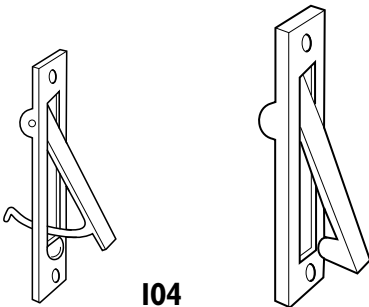

104

106

NUMBER	DIMENSIONS
104	3 7/8" x 3/4"
106	6" x 1 1/4"

SHELF PACK: 10 Polybagged
 FINISHES: 605, 613, 619, 620, 626

NUMBERS/DOOR KNOCKERS

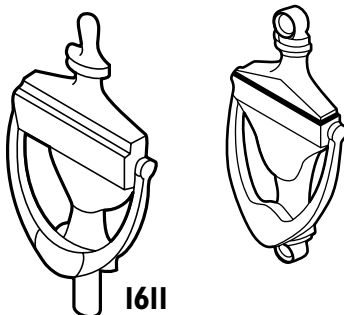

1611

1613



BN4 -

NUMBER	DIMENSIONS	ANSI
1611	6 7/8" x 3 1/2"	L13151
1613	3 7/8" x 2 1/4"	L13151
BN4-	4"	-

SHELF PACK: 10 Polybagged
 FINISHES: 605
 • Forged Brass

How to Order:
 eg: BN4-2-605